

# HYDRAULIC BENDER

## SHEET METAL PRESS BRAKE

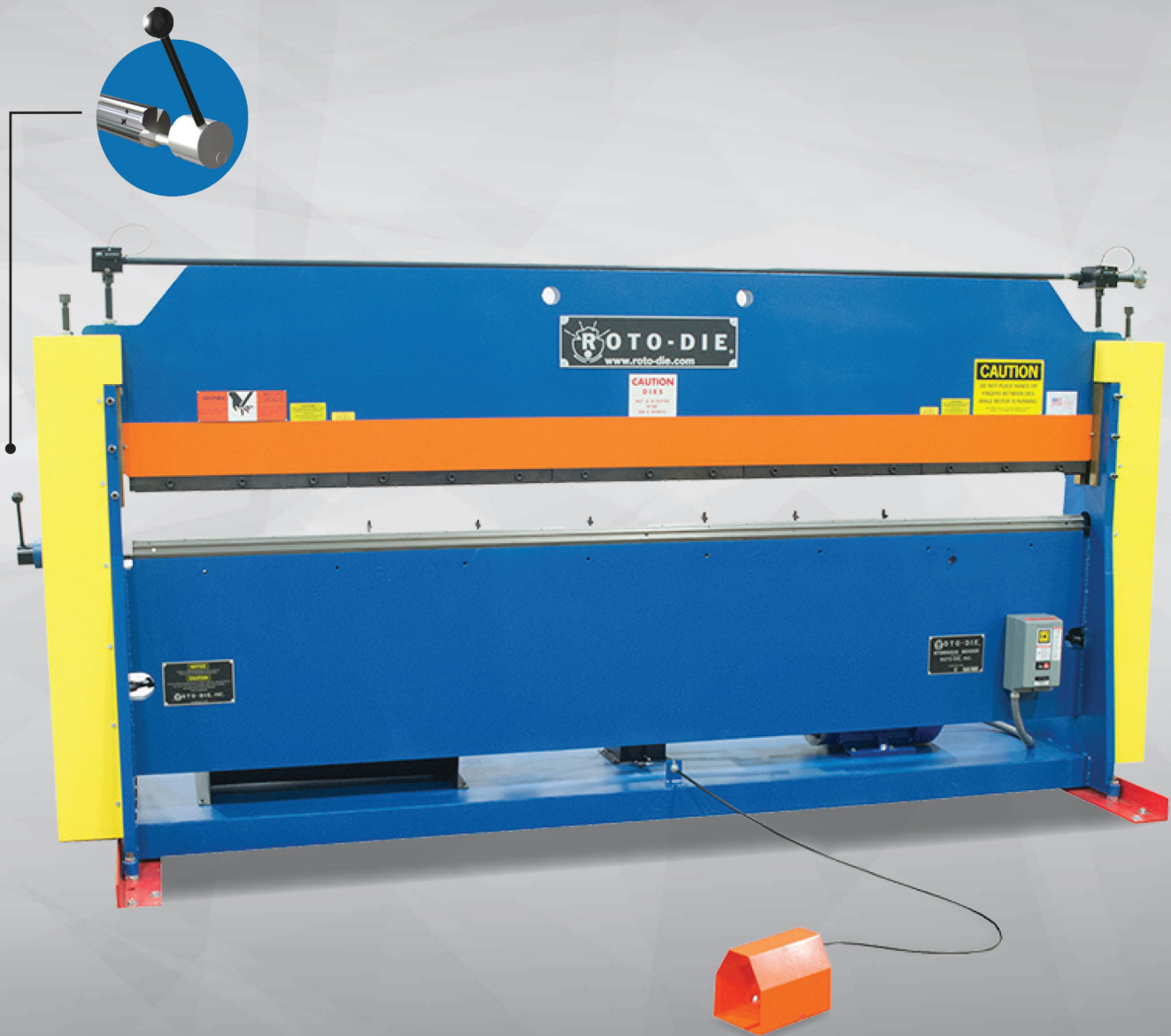

# ROTO-DIE® HYDRAULIC BENDER FEATURES

The Roto-Die® system - over 45 years of sheet metalforming experience. Roto-Die® Hydraulic Benders are shipped complete and ready to tackle your toughest jobs. An extensive, knowledgeable dealer network backed up by factory support is available nationwide to give local service and instruct your personnel. Technical assistance is also available to assist you in obtaining the best production from your machine.

## VERSATILE

**A Roto-Die® Hydraulic Bender is as simple to operate as a hand brake - but has infinitely more production capacity.**

- Merely by rotating the selections lever, one operator can perform all basic sheet-metal forming operations. No dies to change.
- The Roto-Die® Hydraulic Bender forms full length ducts, gravel stops, standing lock seams, flashing and hemming operations accurately and economically.
- The compactness inherent in the cylindrical die design permits acute reverse bends not possible with conventional wide-bend machines.
- The Roto-Die® indexes quickly and accurately to all forming stations. Automatic detention assures positive die alignment.
- Centerline machined upper dies are instantly interchangeable in all Roto-Die® openings without special stops or adjustments.

## PRODUCTIVE

**Most sheet-metal configurations can be formed with one handling by one operator.**

- The ram may be jogged, stopped or returned to "up" position at any point of the stroke. It may also be inched for accurate positioning of the work, reducing material loss and gauge adjustment time.
- Disappearing pins are conveniently located for fast one-person positioning in cross-braking (stiffening) and rectangular duct forming. Pin gauges are easily removed and relocated.

## PROFITABLE

**Roto-Die® Hydraulic Benders are engineered to reduce labor costs while increasing shop productivity.**

- The patented Roto-Die® principle reduces setup time by as much as 70%, compared with other power-forming equipment. Gauge and clearances are adjusted more quickly than on conventional hand brakes.
- One-man operation cuts labor requirements in half on virtually all hand-brake operations.
- Simple adjustments permit operating speeds up to 50 strokes per minute for maximum production output.
- Multiple handling of sheet stock is kept to a minimum. This allows you to fabricate most commercial ventilating jobs, including the TDC duct system, in the Roto-Die® in one-fourth the time ordinary benders require.

## BENEFITS

**Four models to meet your requirements.**

- Proven design - 45 years and thousands of machines in operation.
- All basic sheet metal-forming operations can be made without die change or major adjustments. Infinitely variable speed control for easy selection of ram speed.
- Rugged construction for long, trouble-free operation in heavy duty service.

# ROTO-DIE® MODEL OPTIONS

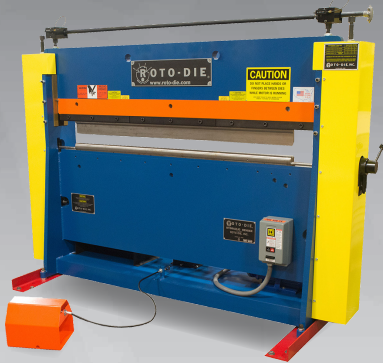

## MODEL 5:

(shown with optional single station)

- Bending Capacity.....60" x 16 gauge



## MODEL 10:

(shown with optional single station and rear-operated back gauge)

- Bending Capacity.....120" x 16 gauge
- Bending Capacity.....72" x 10 gauge\*



## MODEL 15:

(shown with optional single station and front-operated back gauge)

- Bending Capacity.....120" x 14 gauge
- Bending Capacity.....120" x 10 gauge\*



## MODEL 15/12:

(shown with optional single station and front-operated back gauge)

- Bending Capacity.....144" x 16 gauge
- Bending Capacity.....144" x 10 gauge\*

\* = 7/8" die opening with angle insert

PRODUCT SPECIFICATIONS:	Model 5	Model 10	Model 15	Model 15/12
Length of stroke	3"	3"	3"	3"
Strokes per mn. (approx.)	20 to 50	20 to 50	20 to 50	20 to 50
Die Clearance	2-1/8"	2-1/8"	2-1/8"	2-1/8"
Die Space	7-1/2"	7-1/2"	7-1/2"	7-1/2"

OVERALL DIMENSIONS:	Model 5	Model 10	Model 15	Model 15/12
Length	7' 10-1/2"	12' 1"	12' 6-1/4"	14' 6"
Front to Back	22"	22"	22"	22"
Height	5' 3-1/2"	5' 3-1/2"	6'1"	6'1"
Approximate Shipping Weight	3,300 lbs.	5,700 lbs.	8,950 lbs.	10,000 lbs.

# EQUIPMENT OPTIONS

## LIGHT CURTAIN SYSTEM:

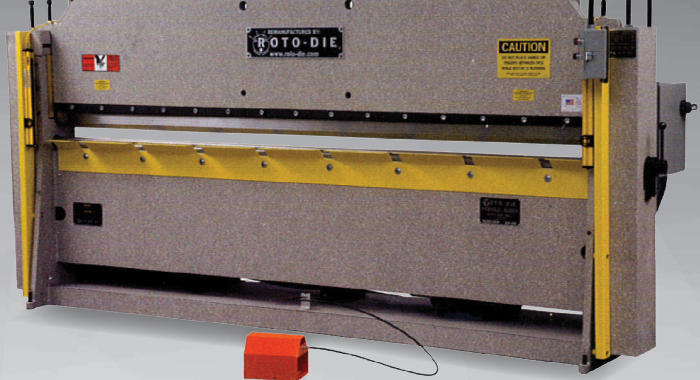
- New Main Control Panel including Lockout/Tag out requirements
  - 18" Category 4 Light Curtain to offer maximum protection above the upper die and below the lower die
  - Muting function (1/4" die opening)
  - Redundant (Primary and Secondary) Proximity Sensors and Electric Solenoid Valves
  - Push-button operator station
  - Front fixed-guard for added safety in the die area
  - New piping, high-pressure fittings and installation hardware
- 
- Manual jog of upper die remains intact
  - Compatible with all Roto-Die® Hydraulic Benders

## BACK GAUGE CNC OPERATION

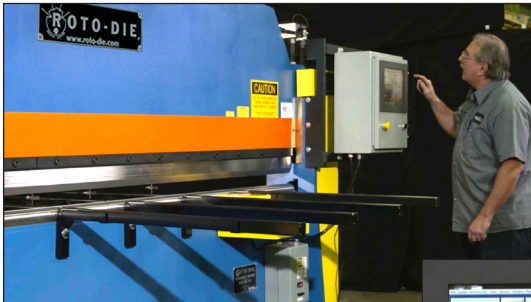

- This single-axis system can be used for single bend "go-to" positioning to speed up batch production.

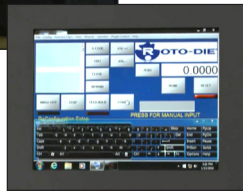

## BACK GAUGE MANUAL OPERATION



- Rear Operated (RD00900)
- Front Operated (RD00975)



## SINGLE STATION AJUSTMENT SYSTEM

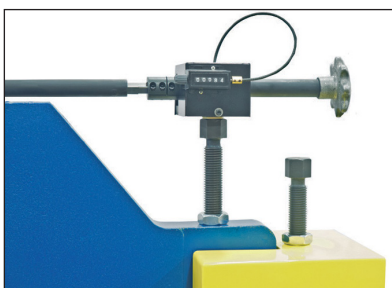

- Permits depth-of-stroke adjustment from one side of machine (RD900001)

## FOOT PEDAL CONVERSION KIT

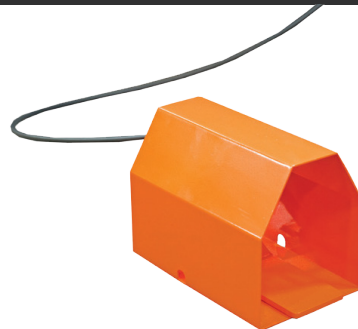

- Converts oldstyle "Treadle Pedal" to an OSHA-Approved covered foot pedal (RD93012)

# EXAMPLES OF DIES

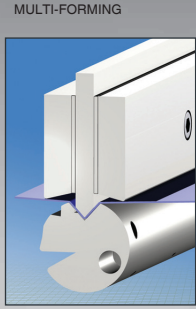
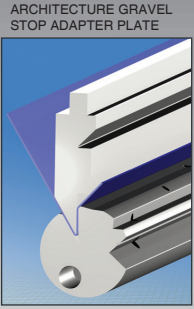
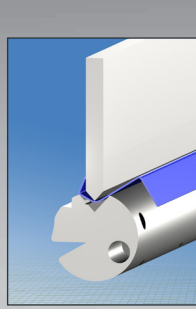
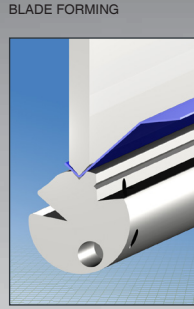
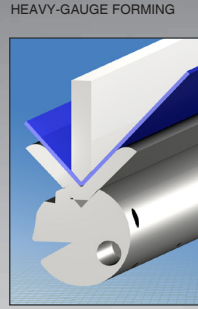
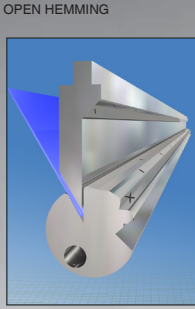
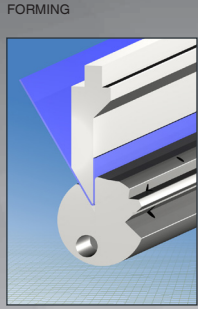

## FORMING OPEN HEMMING

Forming and open hemming are accomplished with standard 30° upper die and No. 37 Roto-Die. Following these sequences, a standing lock seam may be formed without die change or multiple handling of the sheet.

## BLADE FORMING

Many degree-of-bend combinations are quickly and easily formed by bottoming and air-bending.

## ARCHITECTURAL GRAVEL STOP ADAPTER PLATE

This combination die will form 120" of 24-gauge gravel stop with a 3/4" rise. Easy removal of the rear forming section converts the die to acute-angle forming and hemming operations.

## MULTI-FORMING

Damper blades and V-rib shapes may be formed in one stroke in 20-gauge galvanized steel up to 120" long. Shorter lengths may be formed in heavier gauges. The die is adjustable for metals with springback.

## CHANNEL FORMING

90° gooseneck dies (with or without angle inserts) simplify forming light and heavy-gauge channels.

## BOX FORMING

Depths to 1-3/4" may be formed with standard dies.

## HEAVY-GAUGE FORMING

Machined inserts increase bender capacities up to 120" of 10-gauge materials for heavy-gauge or large-radius forming.

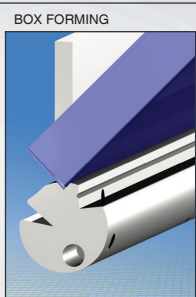
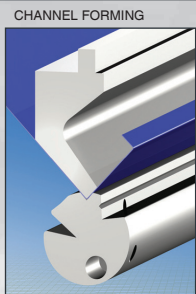

## DIES:

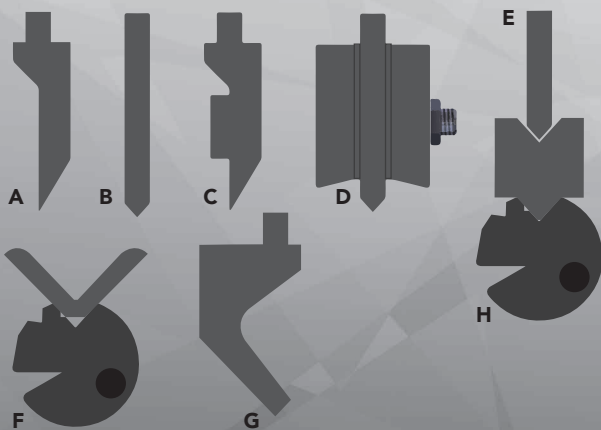

### KEY:

- A #24 Hemming Die
- B #1 Forming Die
- C Gravel Stop Adapter Plate
- D #40 Adjustable Damper Die
- E Narrow #1 Forming Die used with TDC Conversion Die
- F Heavy Gauge Angle Insert
- G #5 Gooseneck Die
- H TDC/TDF Conversion Die

## STANDARD ACCESSORIES:

All units include tooling for five basic forming operations. These dies and accessories are standard:

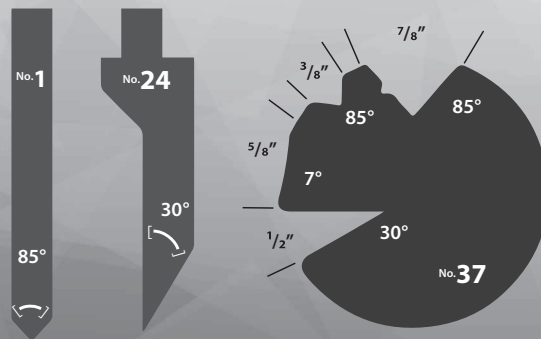

- One #37 Roto-Die® with 7° cross-braking groove
- One #1 forming Die 85°
- One #24 hemming Die 30°
- Six #50 sheet-support arms with clips
- Six #52 gauging blocks
- Six #53 disappearing spring-pin gauges

All models are equipped with depth-of-stroke adjustment with indicators, length-of-stroke adjustment, motor and controls for 230/460 Volts, 3 Phase 60 HZ. (Other 3 Phase voltages also available.)

# REMANUFACTURING PROGRAM

Roto-Die® will remanufacture your machine to the latest specifications or sell you a remanufactured machine. Remanufactured machines carry the same full one-year warranty as our new machines.

**BEFORE**



**AFTER**

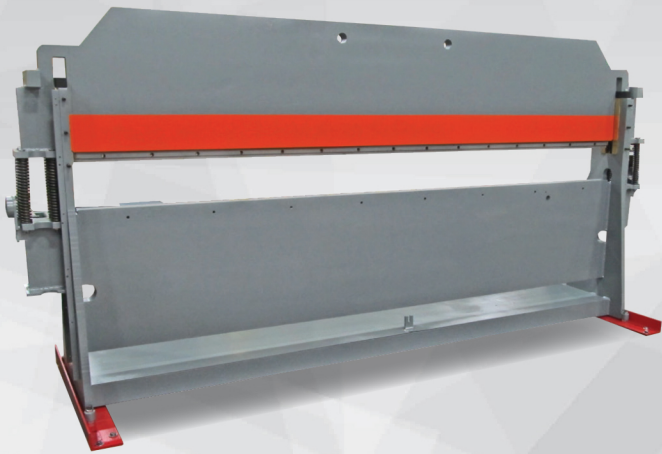

Have your old machine completely remanufactured into a brand new machine. Everything is replaced on the machine except the original bed, ram, and sideplate weldment. All new dies are included.

**FRONT VIEW**



BEFORE PAINT REMOVAL



WELDING INSPECTION REPAIR

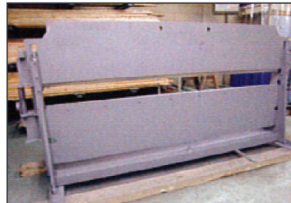

BASE COAT APPLICATION



FINAL COAT APPLICATION

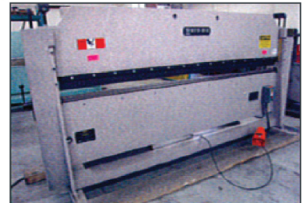

FINAL ASSEMBLY

**REAR VIEW**

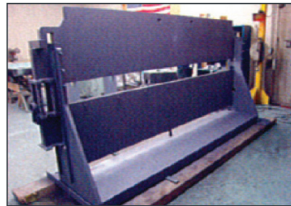

*Please contact Roto-Die® for availability and pricing*



5480 6th Street SW  
Cedar Rapids, IA 52404  
319.364.9181  
sales@mestekmachinery.com  
mestekmachinery.com